

Landquist & Son, Inc

PH: 847-674-6600
 FAX: 847-674-6674
 BIPASS HARDWARE



DATE: _____

TRACK SIZES IN INCHES:

QTY	@	LENGTH	QTY	@	LENGTH
_____	@	_____	_____	@	_____
_____	@	_____	_____	@	_____
_____	@	_____	_____	@	_____
_____	@	_____	_____	@	_____

QTY REQ'D	INVOICE CODE	PART NUM		LIST PRICE	EXTENDED SELL PRICE
_____	POBJ	2200	ALUMINUM BIPASS DOOR TRACK	\$4.00 /FT.	_____
_____	UGBX	116	BIPASS DOOR FLOOR GUIDE (STEEL)	\$5.00 EA.	_____
_____	PVBX	2004	BIPASS DOOR STOP	\$3.00 EA.	_____
_____	PWBX	2165	BIPASS TRACK STOP	\$2.50 EA.	_____
_____	POBX	2226	BIPASS DOOR HANGER (1/16" FRONT DOOR)	\$4.00 EA.	_____
_____	PPBX	2228	BIPASS DOOR HANGER (3/8" BACK DOOR)	\$4.00 EA.	_____
_____	PSBZ	125-619	BIPASS FLUSH PULL (SATIN NICKEL)	\$2.50 EA.	_____

TOTAL PRICE FOR THE HARDWARE
SHIPPING AND HANDLING
TAX %

TOTAL PRICE FOR YOUR ORDER

customer: _____

attn: _____

address: _____

city, state: _____

phone # _____

email _____

P.O. # _____

Ship To: _____

***FOR OFFICE USE ONLY**

OUR ORDER#	H #	CUSTOMER P.O.	SALESMAN	PART TYPE	PLANT CODE	ORDERED BY

MAGIGLIDE bypass closets using Johnson hardware

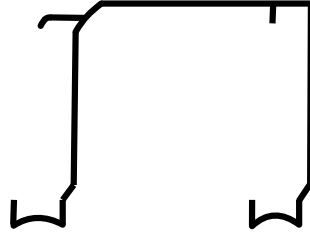
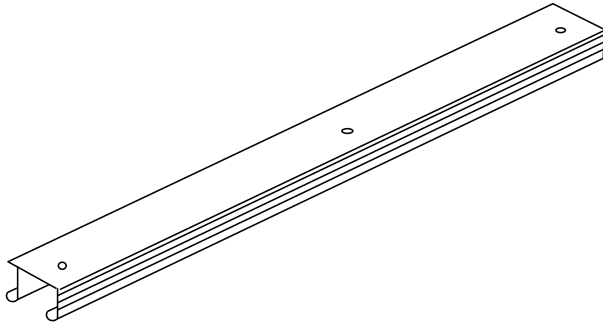

2200 ALUMINUM TRACK

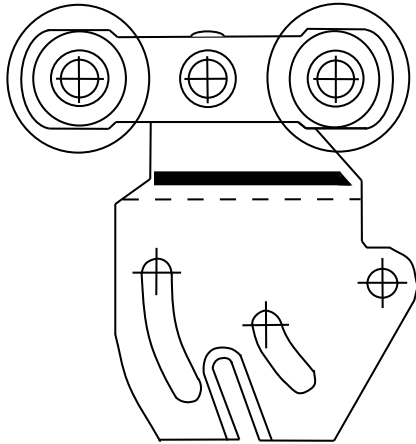

2228 HANGER

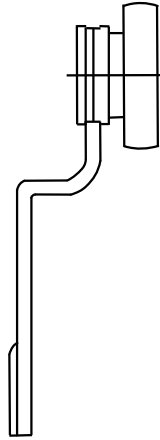

2226 HANGER

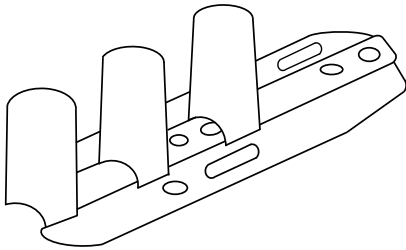
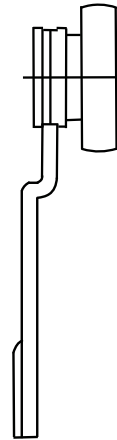

116 DOUBLE FLOOR GUIDE

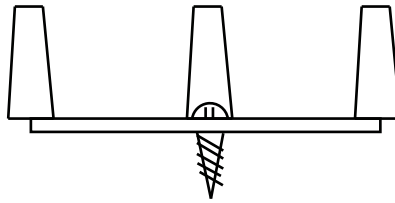

2004 DOOR STOP

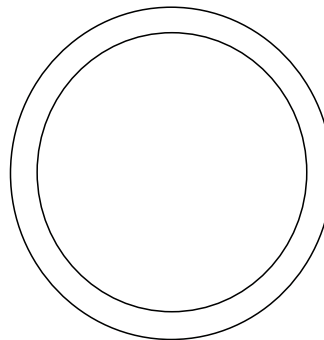
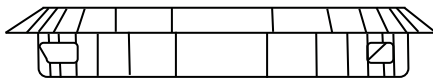
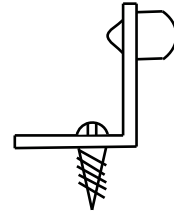

#125 FLUSH PULL

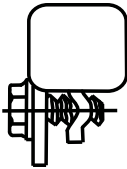
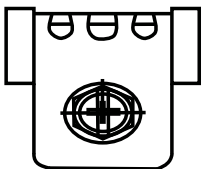

2165 TRACK STOP

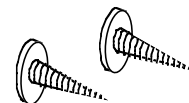

TEK SCREWS